

Approval body for construction products
and types of construction

Bautechnisches Prüfamt

An institution established by the Federal and
Laender Governments



European Technical Assessment

ETA-15/0231
of 21 July 2015

English translation prepared by DIBt - Original version in German language

General Part

Technical Assessment Body issuing the
European Technical Assessment:

Trade name of the construction product

Product family
to which the construction product belongs

Manufacturer

Manufacturing plant

This European Technical Assessment
contains

This European Technical Assessment is
issued in accordance with Regulation (EU)
No 305/2011, on the basis of

Deutsches Institut für Bautechnik

EJOT SDF-K/-S plus 8UB

Plastic anchor for multiple use in concrete and masonry
for non-structural applications

EJOT Baubefestigungen GmbH
In der Stockwiese 35
57334 Bad Laasphe
DEUTSCHLAND

EJOT Herstellwerk 1, 2, 3 und 4
manufacturing plant EJOT 1, 2, 3 and 4

14 pages including 3 annexes which form an integral part
of this assessment

Guideline for European technical approval of "Plastic
Anchors for Multiple Use in Concrete and Masonry for
Non", ETAG 020 structural Applications - Part 1:
"General", Edition March 2012,
used as European Assessment Document (EAD)
according to Article 66 Paragraph 3 of Regulation (EU)
No 305/2011.

The European Technical Assessment is issued by the Technical Assessment Body in its official language. Translations of this European Technical Assessment in other languages shall fully correspond to the original issued document and shall be identified as such.

Communication of this European Technical Assessment, including transmission by electronic means, shall be in full. However, partial reproduction may only be made with the written consent of the issuing Technical Assessment Body. Any partial reproduction shall be identified as such.

This European Technical Assessment may be withdrawn by the issuing Technical Assessment Body, in particular pursuant to information by the Commission in accordance with Article 25(3) of Regulation (EU) No 305/2011.

Specific part

1 Technical description of the product

The EJOT frame fixing SDF-K plus 8UB and SDF-S plus 8UB is a plastic anchor consisting of a plastic sleeve made of polyamide and an accompanying specific screw of galvanised steel or of stainless steel.

The plastic sleeve is expanded by screwing in the specific screw which presses the sleeve against the wall of the drilled hole.

The product description is given in Annex A.

2 Specification of the intended use in accordance with the applicable European Assessment Document

The performances given in Section 3 are only valid if the anchor is used in compliance with the specifications and conditions given in Annex B.

The verifications and assessment methods on which this European Technical Assessment is based lead to the assumption of a working life of the anchor of at least 50 years. The indications given on the working life cannot be interpreted as a guarantee given by the producer, but are to be regarded only as a means for choosing the right products in relation to the expected economically reasonable working life of the works.

3 Performance of the product and references to the methods used for its assessment

3.1 Mechanical resistance and stability (BWR 1)

The essential characteristics regarding mechanical resistance and stability are included under the Basic Works Requirement Safety in use.

3.2 Safety in case of fire (BWR 2)

Essential characteristic	Performance
Reaction to fire	Anchorage satisfy requirements for Class A 1
Resistance to fire	No performance assessed

3.3 Hygiene, health and the environment (BWR 3)

Regarding dangerous substances there may be requirements (e.g. transposed European legislation and national laws, regulations and administrative provisions) applicable to the products falling within the scope of this European Technical Assessment. In order to meet the provisions of Regulation (EU) No 305/2011, these requirements need also to be complied with, when and where they apply.

3.4 Safety and accessibility in use (BWR 4)

Essential characteristic	Performance
Characteristic resistance for tension and shear loads	See Annex C 1, C 2
Characteristic resistance for bending moments	See Annex C 1
Displacements under shear and tension loads	See Annex C 1
Anchor distances and dimensions of members	See Annex B 2, B 3

3.5 Sustainable use of natural resources (BWR 7)

For the sustainable use of natural resources no performance was determined for this product.

4 Assessment and verification of constancy of performance (AVCP) system applied, with reference to its legal base

In accordance with guideline for European technical approval ETAG 020, March 2012 used as European Assessment Document (EAD) according to Article 66 Paragraph 3 of Regulation (EU) No 305/2011 the applicable European legal act is: 97/463/EC.

The system to be applied is: 2+

5 Technical details necessary for the implementation of the AVCP system, as provided for in the applicable EAD

Technical details necessary for the implementation of the AVCP system are laid down in the control plan deposited with Deutsches Institut für Bautechnik.

Issued in Berlin on 21 July 2015 by Deutsches Institut für Bautechnik

Uwe Bender
Head of Department

beglaubigt:
Ziegler

EJOT SDF-K plus 8UB

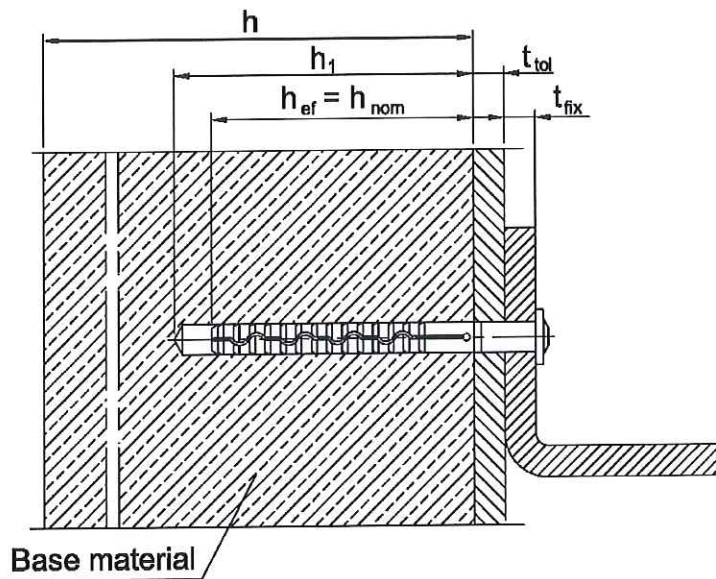

SDF-K plus Ø8UB

EJOT SDF-S plus 8UB

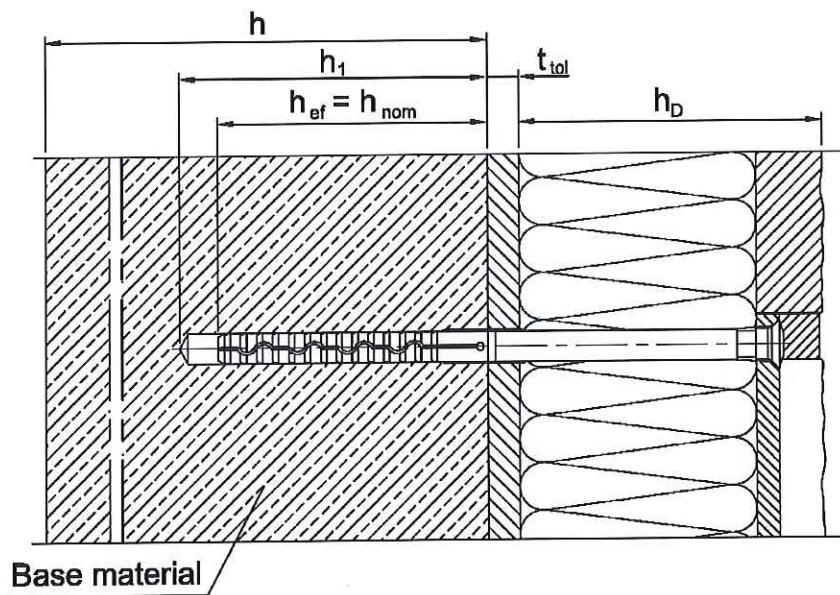

SDF-S plus Ø8UB

- Legend:
- h_D = thickness of insulation material
 - h_{nom} = overall anchor embedment depth in the base material
 - h = thickness of member (wall)
 - h_1 = depth of drilled hole to deepest point
 - t_{tol} = thickness of equalizing layer or non-load-bearing coating
 - t_{fix} = thickness of fixture

EJOT SDF-K/-S plus 8UB

Product description
Installed condition

Annex A 1

Anchor sleeve: head collar version

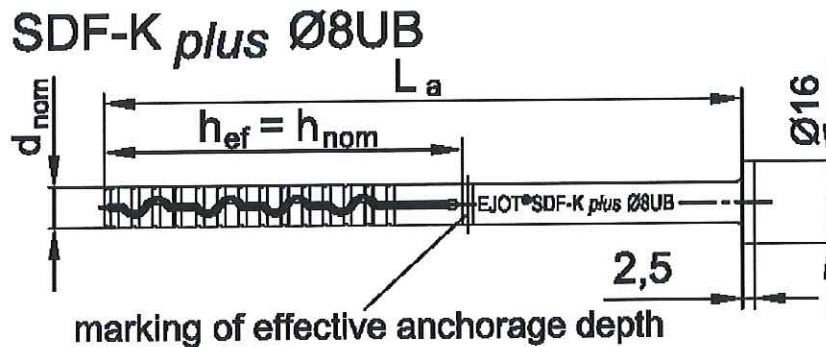

Anchor marking:

manufacturer, anchor type incl. head type, diameter, length
Example: EJOT SDF-K plus Ø8UB x L_a

Anchor sleeve: Countersunk version

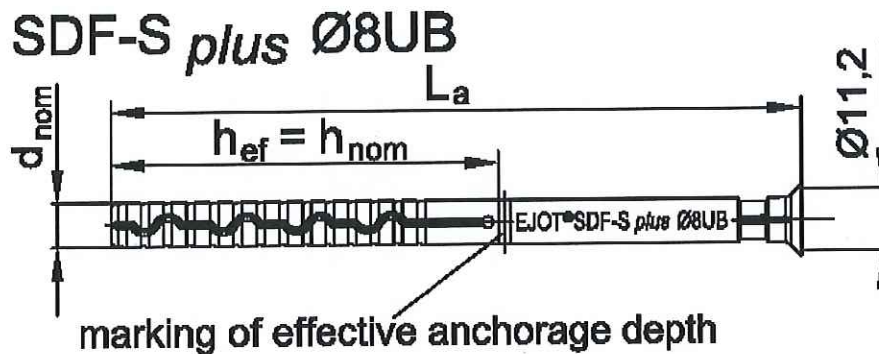

Anchor marking:

manufacturer, anchor type incl. head type, diameter, length
Example: EJOT SDF-S plus Ø8UB x L_a

Specific screw

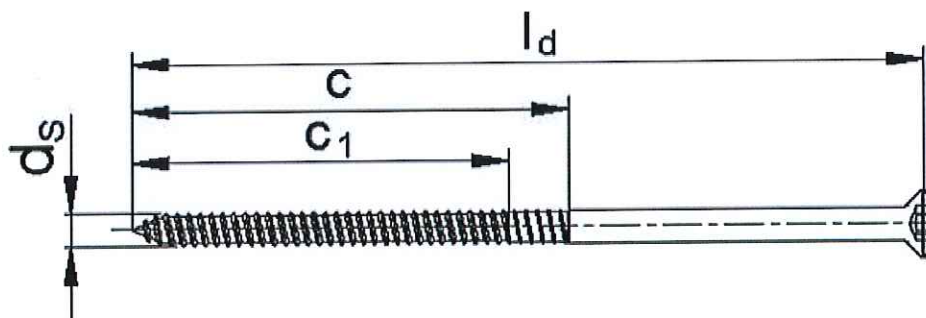

Screw head



EJOT SDF-K/-S plus 8UB

Product description

Marking and dimension of the anchor sleeve
Specific screw

Annex A 2

Table A1: Dimensions

Anchor Type	Anchor sleeve				Specific screw			
	d_{nom}	h_{nom}	min L_a	max L_a	l_d	d_s	c_1	c
	[mm]	[mm]	[mm]	[mm]	[mm]	[mm]	[mm]	[mm]
SDF-K/-S plus 8UB	8	70	80	300	$L_a + 8\text{mm}$	5,5	60	70

Table A2: Materials

Name	Materials
Anchor sleeve	Polyamide, PA 6 colour: green
Specific screw	Steel, electrogalvanized $\geq 5 \mu\text{m}$ according to EN ISO 4042, blue passivated $f_{yk} = 480 \text{ N/mm}^2$, $f_{uk} = 600 \text{ N/mm}^2$
	stainless steel according EN 10088-3:2014 $f_{yk} = 450 \text{ N/mm}^2$, $f_{uk} = 700 \text{ N/mm}^2$ material number 1.4401 or 1.4571 material number 1.4301 or 1.4567

EJOT SDF-K/-S plus 8UB

Product description

Dimensions of the anchor sleeve and the specific screw
 Materials

Annex A 3

Specifications of intended use

Anchorage subject to:

- Static and quasi-static loads.
- Multiple fixing of non-structural applications

Base materials:

- Reinforced or unreinforced normal weight concrete with strength classes \geq C12/15 (use category a) according to EN 206-1:2000, Annex C 1.
- Solid brick masonry (use category b) according to Annex C 2.
Note: The characteristic resistance is also valid for larger brick sizes and higher compressive strength of the masonry unit.
- Hollow brick masonry (use category c) according to Annex C 2.
- Mortar strength class of the masonry \geq M2,5 according to EN 998-2:2010.
- For other base materials of the use categories a, b or c the characteristic resistance of the anchor may be determined by job site tests according to ETAG 020, Annex B, Edition March 2012.

Temperature Range:

- c: - 40° C to 50° C (max. short term temperature + 50° C and max long term temperature + 30° C)

Use conditions (Environmental conditions):

- Structures subject to dry internal conditions (zinc coated steel, stainless steel)
- The specific screw made of galvanised steel may also be used in structures to external atmospheric exposure, if the area of the head of the screw is protected against moisture and driving rain after mounting of the fixing unit in this way, that intrusion of moisture into the anchor shaft is prevented. Therefore there shall be an external cladding or a ventilated rainscreen mounted in front of the head of the screw and the head of the screw itself shall be coated with a soft plastic, permanently elastic bitumen-oil-combination coating (e. g. undercoating or body cavity protection for cars)
- Structures subject to external atmospheric exposure (including industrial and marine environment) and to permanently damp internal condition, if no particular aggressive conditions exist (stainless steel).
- Note: Particular aggressive conditions are e.g. permanent, alternating immersion in seawater or the splash zone of seawater, chloride atmosphere of indoor swimming pools or atmosphere with extreme chemical pollution (e.g. in desulphurization plants or road tunnels where de-icing materials are used).

Design:

- The anchorages are to be designed in accordance with the ETAG 020, Annex C under the responsibility of an engineer experienced in anchorages and masonry work.
- Verifiable calculation notes and drawings shall be prepared taking account of the loads to be anchored, the nature and strength of the base materials and the dimensions of the anchorage members as well as of the relevant tolerances. The position of the anchor is indicated on the design drawings.
- Fasteners are only to be used for multiple use for non-structural application according to ETAG 020, Edition March 2012.

Installation:

- Hole drilling by the drill modes according to Annex C1 and C 2 for use category a, b and c
- Anchor installation carried out by appropriately qualified personnel and under the supervision of the person responsible for technical matters of the site
- Installation temperature from 0°C to + 50°C
- Exposure to UV due to solar radiation of the anchor not protected \leq 6 weeks

EJOT SDF-K/-S plus 8UB

Intended use
Specifications

Annex B 1

Table B1: Installation Parameters

Anchor Type	SDF-K/-S plus 8UB	
Drill hole diameter	d_0 [mm] =	8
Cutting diameter of drill bit	d_{cut} [mm] ≤	8,45
Depth of drill hole to deepest point	h_1 [mm] ≥	80
Overall anchor embedment depth in the base material	h_{nom} [mm] ≥	70
Diameter of clearance hole in the fixture	d_f [mm] ≤	8,5
Minimum temperature during setting process	T [°C] =	0
Temperature range (c)	T [°C] =	+ 30 / + 50

Table B2: Minimum thickness of member, edge distance and spacing in concrete

Anchor Type	Characteristic edge distance and spacing		Minimum edge distance and spacing		Minimum thickness of member
	$c_{cr,N}$	$s_{cr,N}$	c_{min}	s_{min}	
SDF-K/-S plus 8UB	[mm]	[mm]	[mm]	[mm]	h_{min} [mm]
Concrete C 20/25	60	75	80	50	120

Fixing points with a spacing $a \leq s_{cr,N}$ are considered as a group with a max. characteristic resistance $N_{Rk,p}$ acc. to Table C3. For a spacing $a > s_{cr,N}$ the anchors are considered as single anchors, each with a characteristic resistance $N_{Rk,p}$ acc. to Table C3.

Scheme of distance and spacing in concrete

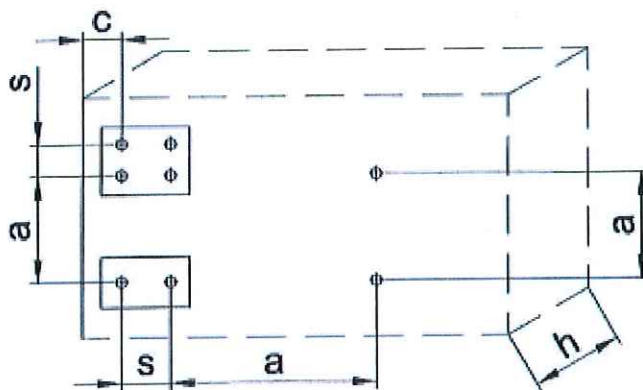

EJOT SDF-K/-S plus 8UB

Intended use
Installation parameters,
Distance and spacing for use in concrete

Annex B 2

Tabelle B3: Minimum thickness of member, edge distance and spacing in solid and hollow brick

SDF-K/-S plus 8UB	Minimum thickness of member h_{min} [mm]	Minimum edge distance c_{min} [mm]	Minimum spacing	
			vertical to edge $s_{1,min}$ [mm]	parallel to edge $s_{2,min}$ [mm]
Clay brick, Mz (DIN 105-100:2012-01 / EN 771-1:2011)	115	30	60	120
Calcium silicate solid brick, KS (DIN V 106:2005-10 / EN 771-2:2011)	175	30	60	120
Vertically perforated clay bricks, Hlz (DIN 105-100:2012-01 / EN 771-1:2011)	175	100	100	100
Hollow calcium silicate brick, KSL (DIN V 106:2005-10 / EN 771-2:2011)	175	100	100	100
Hollow brick lightweight concrete, Hbl (DIN V 18151-100:2005-10/ EN 771-3:2011)	300	100	100	100

$a \geq \max(250 \text{ mm}; s_{1,min}; s_{2,min})$

Scheme of distance and spacing in masonry

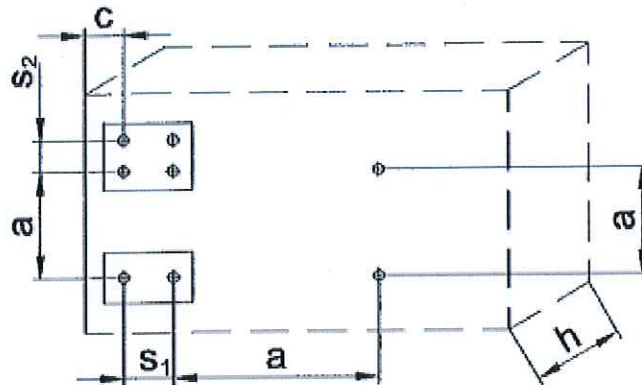

EJOT SDF-K/-S plus 8UB

Intended use
Distance and spacing for use in masonry

Annex B 3

Installation instructions

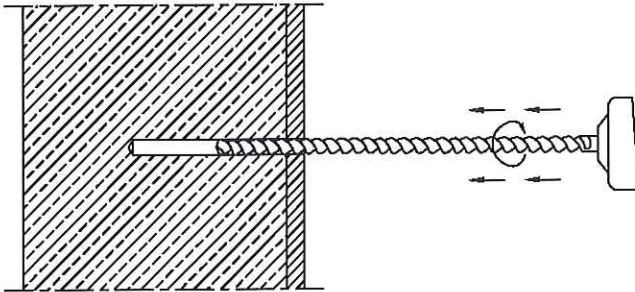

Drill the hole perpendicular to the substrate surface. Clean the drill hole 3x.

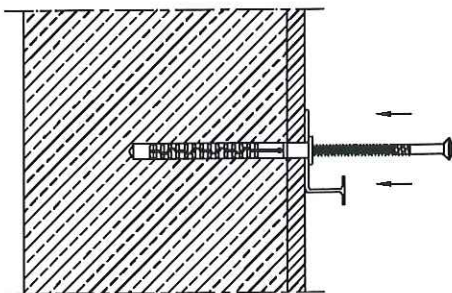

Place the anchor into the drill hole.
The bottom side of the anchor plate must be flush with the rail.

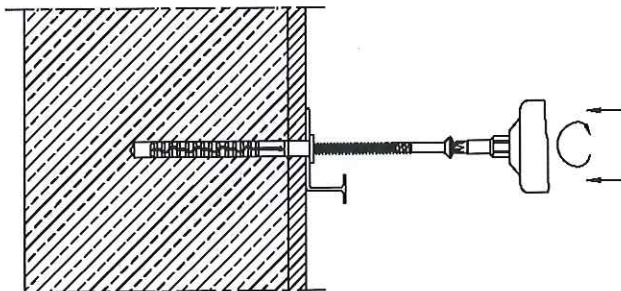

Install the screw into the anchor.

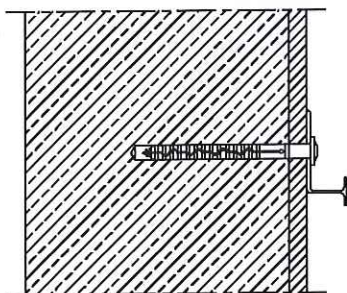

Installed condition of
EJOT SDF-K plus 8UB.

EJOT SDF-K/-S plus 8UB

Intended use
Installation instructions EJOT SDF-K plus 8UB

Annex B 4

Installation instructions

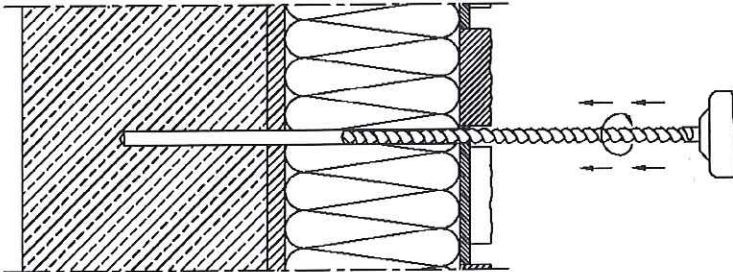

Drill the hole perpendicular to the substrate surface. Clean the drill hole 3x.

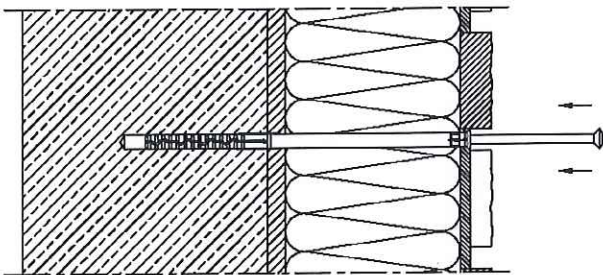

Place the anchor into the drill hole.

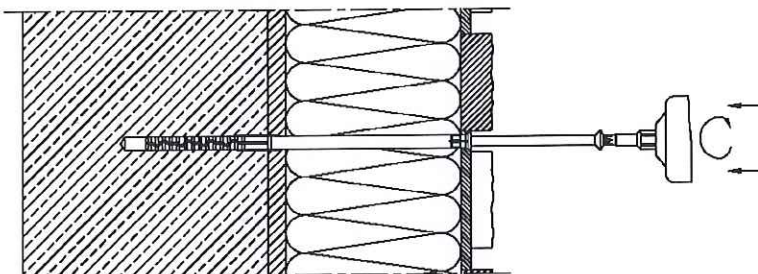

Install the anchor.

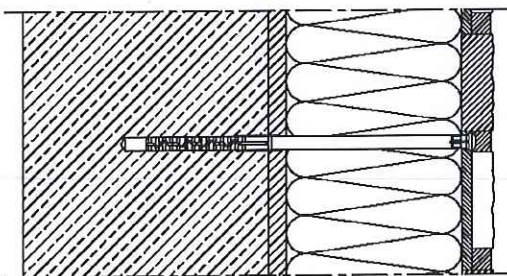

Installed condition of
EJOT SDF-S plus 8UB.

EJOT SDF-K/-S plus 8UB

Intended use
Installation instructions EJOT SDF-S plus 8UB

Annex B 5

Table C1: Characteristic resistance of the screw

Failure of expansion element	SDF-K/-S plus 8UB		
Base materials	Galvanised steel		Stainless steel
Characteristic tension resistance	$N_{Rk,s}$ [kN]	11,3	13,2
Characteristic shear resistance	$V_{Rk,s}$ [kN]	6,4	7,4
Characteristic bending resistance	$M_{Rk,s}$ [Nm]	9,9	11,6

Table C2: Characteristic resistance for pullout failure¹⁾ for use in concrete \geq C16/20

	SDF-K/-S plus 8UB	
Temperature range	30 / 50 °C	
Characteristic tension resistance	$N_{Rk,p}$ [kN]	1,5

¹⁾ drill method: hammer drilling

Table C3: Displacements²⁾ under tension and shear loading in concrete and masonry

Anchor Type	Tension load F [kN]	Displacements under tension load		Shear load F [kN]	Displacements under shear load	
		δ_{NO} [mm]	$\delta_{N\infty}$ [mm]		δ_{VO} [mm]	$\delta_{V\infty}$ [mm]
SDF-K/-S plus 8UB	0,6	0,26	0,52	2,2	1,04	1,56

²⁾ intermediate values by linear interpolation

EJOT SDF-K/-S plus 8UB

Performances

Characteristic resistance of the screw, characteristic resistance for use in concrete,
 Displacements in concrete and masonry

Annex C 1

Table C4: Characteristic resistance F_{RK} for use in solid or perforated masonry

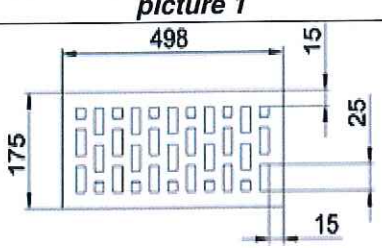
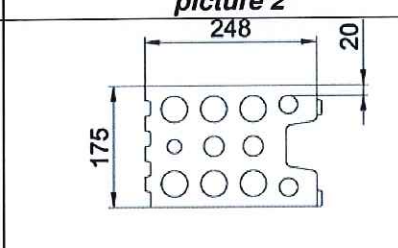
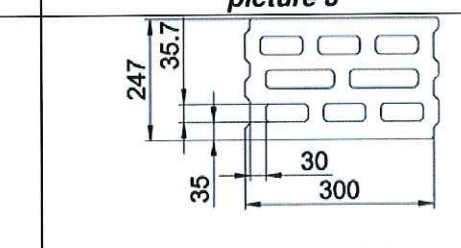
Anchor Type					SDF-K/-S plus 8UB
Base materials	Bulk Density class ρ [kg/dm ³]	minimum compressive strength f_b [N/mm ²]	min. format or min. size (L x W x H) [mm]	Drilling method ¹⁾	F_{RK} [kN]
solid masonry					
Clay brick, Mz e.g. according to DIN 105-100:2012-01 / EN 771-1:2011	$\geq 1,8$	36	NF (240 x 115 x 71)	H	3,5
Calcium silicate solid brick, KS e.g. according to DIN V 106:2005-10 / EN 771-2:2011	$\geq 1,8$	28	3 DF (240 x 175 x 113)	H	3,5
perforated masonry					
Vertically perforated clay bricks, Hlz e.g. according to DIN 105-100:2012-01 / EN 771-1:2011 (<i>picture 1</i>)	$\geq 0,75$	12	12 DF (498 x 175 x 238)	R	0,75
Hollow calcium silicate brick, KSL e.g. according to DIN V 106:2005-10 / EN 771-2:2011 (<i>picture 2</i>)	$\geq 1,4$	20	6 DF (248 x 175 x 248)	R	2,5
Hollow brick lightweight concrete, Hbl e.g. according to DIN V 18151-100:2005-10/ EN 771-3:2011 (<i>picture 3</i>)	$\geq 0,9$	4	10 DF (247 x 300 x 249)	R	0,9
picture 1		picture 2		picture 3	
					

¹⁾ H = Hammer drilling / R = Rotary drilling

EJOT SDF-K/-S plus 8UB

Performances

Characteristic resistance for use in solid or perforated masonry

Annex C 2